



Characteristics



- Energy saving heat pump air curtains: Up to 70% reduction in costs and CO₂ emissions (heating mode).
- Specially designed to be installed in all type of revolving doors. Two possible layouts, tailored dimensions: standard (on top mounting) or inverted (false ceiling mounting).
- Self-supporting casing construction made of galvanized steel plate, finished in structural epoxy-polyester painting white colour RAL9016 as standard. Other colours or stainless steel are available on request.
- Large perforated inlet grille avoiding intensive maintenance.
- Circular anodized aluminium outlet vanes, airfoil shaped.
- EC Double-inlet centrifugal fans driven by an external rotor motor and low noise level, with very low consumption efficiency fans.
- Includes direct expansion coil with sensors. Optional condensate water pump.
- CS-5DX-NE Plug&Play control with 5 speeds and telephone cable 7m included.
- Requires DAIKIN DX Interface KIT adapted for air curtain and programmable control, please consult.
- Ready to connect to DAIKIN Inverter outdoor heat pump unit (R410A) and expansion valve not included, the customer should purchase it.

Specifications

Model	Airflow m ³ /h	Outdoor Unit 230Vx1	Outdoor Unit 400Vx3	Daikin Direct Expansion Valve	Power Fan 230V-50Hz kW	Current Fan 230V-50Hz A	Noise Level (5 m) dB(A)	Weight kg
ROTO ECG 1000 DX10-DA	2190	ERQ 100 AV1	-	EKEXV 80	0,225	1,95	61	-
ROTO ECG 1500 DX13-DA	2920	ERQ 100 AV1	-	EKEXV 100	0,300	2,60	62	-
ROTO ECG 1500 DX15-DA	2920	ERQ 125 AV1	ERQ 125 AW1	EKEXV 125	0,300	2,60	62	-
ROTO ECG 2000 DX24-DA	4380	-	ERQ 200 AW1	EKEXV 200	0,450	3,90	63	-
ROTO ECG 2500 DX25-DA	5110	-	ERQ 200 AW1	EKEXV 200	0,525	4,55	64	-
ROTO ECG 2500 DX29-DA	5110	-	ERQ 250 AW1	EKEXV 250	0,525	4,55	64	-

DAIKIN Inverter Outdoor Units	Heating Capacity kW	Heating Power kW	SCOP or COP	Cooling Capacity kW	Cooling Power kW	SEER or EER	Power Supply	Pipes Gas Liquid inch	Pipes Minimum Length m	Pipes Maximum Length m	Pipes Maximum Height m
ERQ 100 AV1	12,5	2,74	4,56	11,2	2,81	3,99	230Vx1	5/8 3/8	-	55	35
ERQ 125 AV1	16,0	3,86	4,15	14,0	3,51	3,99	230Vx1	5/8 3/8	-	55	35
ERQ 125 AW1	16,0	4,00	4,00	14,0	3,52	3,98	400Vx3	5/8 3/8	-	55	30
ERQ 200 AW1	25,0	5,56	4,50	22,4	5,22	4,29	400Vx3	3/4 3/8	-	55	30
ERQ 250 AW1	31,5	7,70	4,09	28,0	7,42	3,77	400Vx3	7/8 3/8	-	55	30

Energy efficiency: SCOP/SEER seasonal ≤12kW, COP/EER >12kW.

Outdoor unit capacities depending on standard conditions: heating 20°CDB indoor / 7°CDB and 6°CWB outdoor, cooling 27°CDB and 19°CWB indoor / 35°CDB outdoor.

When adverse weather conditions, the outdoor unit capacity can decrease. It is recommendable to oversize the units.



Characteristics



- Energy saving heat pump air curtains: Up to 70% reduction in costs and CO₂ emissions (heating mode).
- Specially designed to be installed in all type of revolving doors. Two possible layouts, tailored dimensions: standard (on top mounting) or inverted (false ceiling mounting).
- Self-supporting casing construction made of galvanized steel plate, finished in structural epoxy-polyester painting white colour RAL9016 as standard. Other colours or stainless steel are available on request.
- Large perforated inlet grille avoiding intensive maintenance.
- Circular anodized aluminium outlet vanes, airfoil shaped.
- EC Double-inlet centrifugal fans driven by an external rotor motor and low noise level, with very low consumption efficiency fans.
- Includes direct expansion coil with sensors. Optional condensate water pump.
- CS-5DX-NE Plug&Play control with 5 speeds and telephone cable 7m included.
- Requires DAIKIN VRV Interface KIT adapted for air curtain and programmable control, please consult.
- Ready to connect to DAIKIN VRV outdoor heat pump unit (R410A) and expansion valve not included, the customer should purchase it.

Specifications

Model	Airflow m ³ /h	Daikin Direct Expansion Valve	Power Fan 230V-50Hz kW	Current Fan 230V-50Hz A	Noise Level (5 m) dB(A)	Weight kg
ROTO ECG 1000 VRV10-DA	2190	EKEXV 80	0,225	1,95	61	-
ROTO ECG 1500 VRV13-DA	2920	EKEXV 100	0,300	2,60	62	-
ROTO ECG 1500 VRV15-DA	2920	EKEXV 125	0,300	2,60	62	-
ROTO ECG 2000 VRV20-DA	4380	EKEXV 200	0,450	3,90	63	-
ROTO ECG 2000 VRV24-DA	4380	EKEXV 200	0,450	3,90	63	-
ROTO ECG 2500 VRV25-DA	5110	EKEXV 200	0,525	4,55	64	-
ROTO ECG 2500 VRV29-DA	5110	EKEXV 250	0,525	4,55	64	-

DAIKIN VRV compatible Outdoor Units

VRV IV HP (Heat Pump)

VRV IV HR (Heat Recovery)



When adverse weather conditions, the outdoor unit capacity can decrease. It is recommendable to oversize the units.



Layouts and dimensions

Rotowind air curtains are tailor-made for any kind of revolving door according to the following layouts:

Standard: On top mounting

Inverted: False ceiling mounting

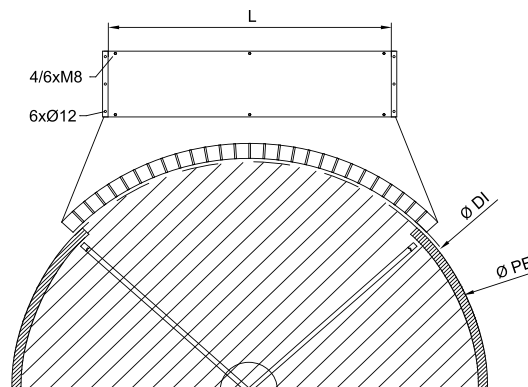
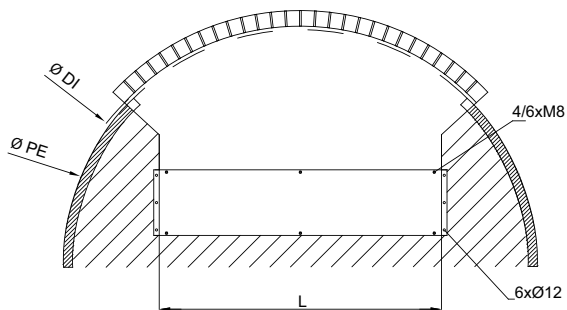
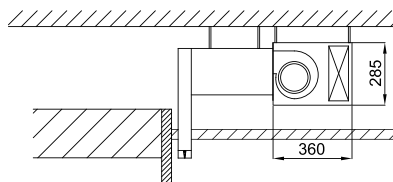
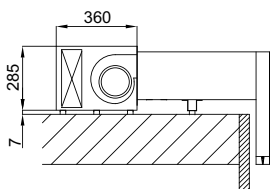
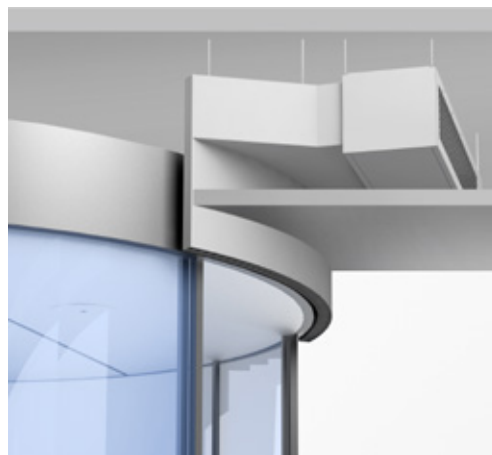

Fixation system

Optional decorative front cover



Fixed onto the door

Hanging from the ceiling

RAL 9016 (standard), optional:

- Colour from RAL palette
- Stainless steel AISI 304